

# 21ST

GARDENART

TWENTYFIRST IS A BRAND OF ELBI S.P.A.

---

## Our experience at your service



# The origins

You have to go very far back in time to find the roots and origins of ELBI.

The place is Padua and the year is **1965** when **Luigi Brustio**, a young man with a craft spirit and the will to grow, starts his own business as a small professional craftsman in a modest workshop for rent at the borders of the neighborhood Church.

The main activity consists in working for third parties, namely the construction of autoclaves.



## Founding the headquarters

Just a few years later the manufacture activity moves to a larger plant in Vigodarzere (Padua), where the production gradually grows up. Time passes by, the business improves, the company name becomes official: Elbi.



ELBI: office area in the 80's



In the year 1981, having overgrown the capacity of the Vigodarzere facility, the company moves to its present headquarters in Limena (Padua), thus expanding its production capacity.

Elbi is now a true and proper industry.



# ELBI: HEADQUARTERS & PRODUCTION PLANT

During The 80'S in Limena, Padua



## Rotomoulding technology: a new production plant

In **1989** the company branches off into a new line of products, processing plastic materials and manufacturing rotational-molded polyethylene tanks.

This production technology represents to Elbi the springboard to explore and enter new markets.





## ELBI of America, Inc. in Houston, TX – U.S.A.

In 1990 Elbi of America, Inc. is founded in Houston, Texas.

Initially the new company concentrates on simple marketing and sales activities, learning about the culture and mentality of the vast and complex American continent.

In 1996 Elbi of America becomes the official manufacturing headquarters for the fixed bladder tanks, thus bringing production closer to the target market.



# Entering the market of GARDEN decoration

In **1994**, thanks to the in-house rotomoulding technology, ELBI starts the production and marketing of polyethylene pots for plants and flowers.

The company thus enters the new market of gardening, expanding its know-how in both technological and commercial field.



# Entering the market of Waste Management

The company's third sales division deals with Environment and is established in 1997 to design and produce containers for selective collection of waste.

The technology used for manufacturing these products is once again the rotomolding of polyethylene.





# The new production plant for southern Italy

In 2001 a new production facility is opened nearby the city of Bari, in southern Italy, and its activity is mainly dedicated to the manufacture of containers made of rotational-molded polyethylene.

Here resides the plant for the extrusion and the pulverization of the polyethylene granules, the raw material that feeds the rotomolding production process. In addition, the largest rotational plant in Europe is installed there.





**21ST**  
GARDENART  
TWENTYFIRST IS A BRAND OF ELBI S.P.A.

*Collections*

## NUDE collection

ELEGANCE, SOBRIETY, SIMPLICITY. These are the main characteristics of the nude collection. Thanks to the wide range of colors offered, these models are ideal for furnishing with style all kinds of environments, both indoor and outdoor. In particular, the **FENICE** line has been designed in modular version in order to exploit the spaces coherently.





# FENICE series





## FIORE collection

INNOVATION AND MODERNITY. The **FIORE** collection represents the innovation of design, a research process of new shapes in continuous evolution that flourishes in a new fresh, sober and original style. It's a continuous, slow and silent growth: life flows, progress evolves





# TERRA collection

MEMORY AND TRADITION. The TERRA collection reproduces the tradition of the ancient art of hand-made Tuscan terracotta pots. A collection that translates and brings knowledge, memories and traditions to the present. A journey in time and in space.





# ALL OUR COLORS

## TERRA COLLECTION



## FIORE COLLECTION



## NUDE COLLECTION



NEUTRO  
00100

## FENICE SERIES



NEUTRO  
0100

# PET collection – JAR & COMPOSTER

## PET collection



## JAR & COMPOSTER



# Optional

Saucers

Lighting kit

Anchor plate kit

Drainage hole





# SAUCERS

Rectangular



Round



Corner



Square



Semicircle



# LIGHTING KIT WITH CABLE

## BULB SOCKET E27 - COD. Mo50210

Black neoprene cable with double insulation | Schucko plug 10A | 250V

230/240V 50Hz \_ Class II \_ IP44 / IP67

## BULBS

\_ Cod. Mo5A010 - LED (cold white 6000°K) E27 | Class A+ | Power max 9 watt

\_ Cod. Mo5A030\* - Bulb A60\_LED RGB SMART APP | 2700-6500°K | E27 | 230V | 10W | 810 LUMEN | Class A+

\* *ATTENTION: In order to manage the RGB LED bulb SMART APP you don't need the remote control: you just need to install the free APP on your smart devices!*

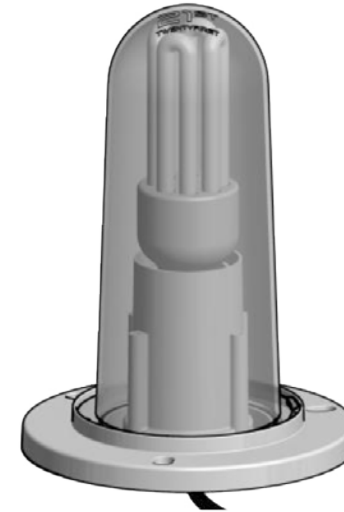

# Anchor plate kit // Drainage hole (only for DOUBLE WALL pots)

POT MODEL	SIZE	COD. PLATE
HILO 80	SHORT	M052400
HILO 100	MEDIUM	M052521
HILO 130	TALL	M052620
MIRAGE 60	SHORT	M052450
MIRAGE 80	MEDIUM	M052520
MIRAGE 100	TALL	M052701
NAiF 80	SHORT	M052360
NAiF 100	MEDIUM	M052420
NAiF 130	TALL	M052500

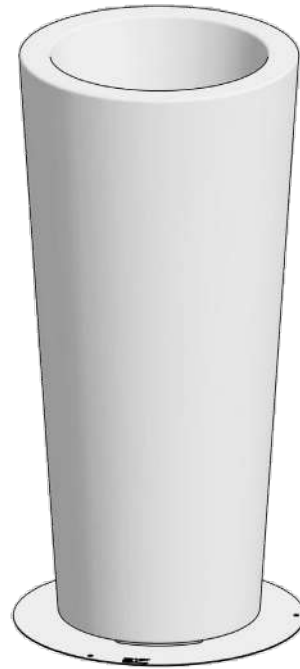

## Drainage hole (only for DOUBLE WALL pots)

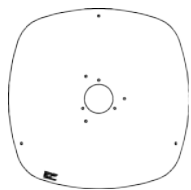
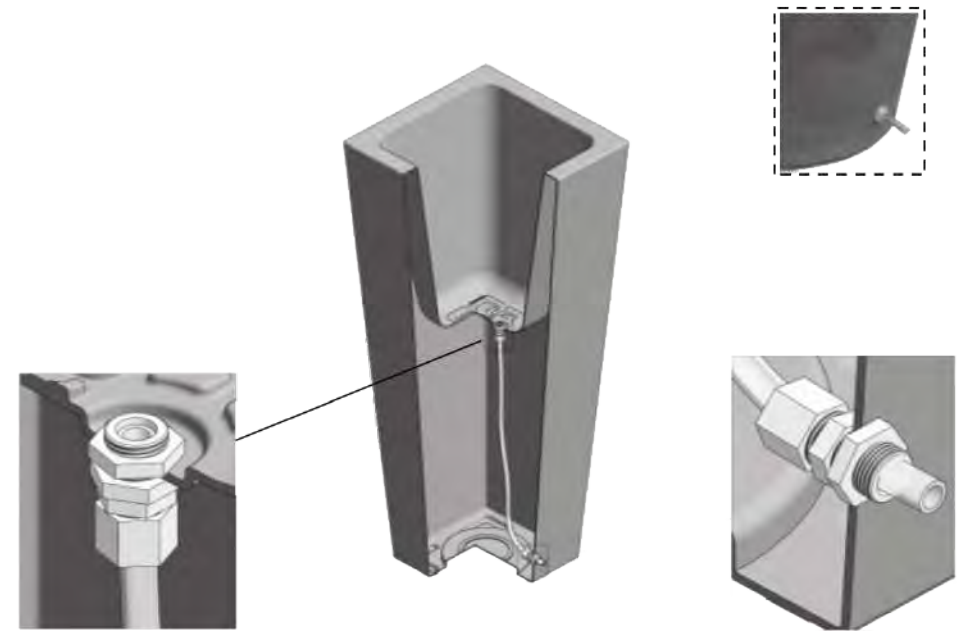

NAiF

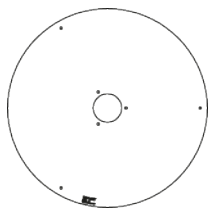

HILO // MIRAGE



# FEATURES OF OUR POTS

- » **Sustainable:** no polluting solvents are employed during the production process
- » **Ecological:** they are obtained with inert and recyclable raw materials
- » **Lightweight:** easy to handle for fast reorganization of space
- » **Minimal maintenance:** can be cleaned quickly and easily
- » **Weather resistant:** pots made of polyethylene (PE)\* bear sudden thermal excursions from  $-30^{\circ}\text{C}$  to  $+50^{\circ}\text{C}$
- » **Robust and shock resistant**
- » **U.V. Resistant**
- » **Long lasting**
- » **Excellent value for money**

*\* Some items are made of polypropylene (PP)*



# ECOLOGICAL, SINCE ALWAYS

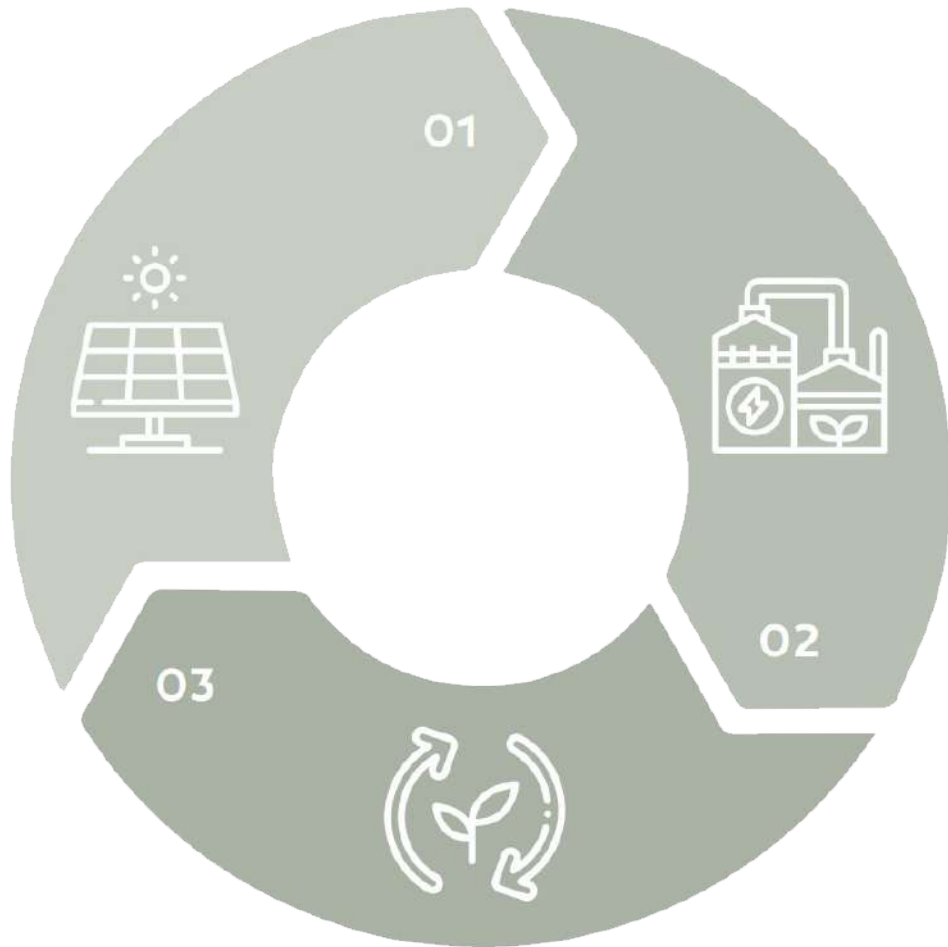

- » **1** \_ In our production processes we use as well clean and renewable energy thanks to our two photovoltaic plants. In the Limena (PD) headquarters, the solar panels cover an area of approx 8.500 m<sup>2</sup> producing around 1.000.000 kW per year, while in the Modugno (BA) facility the surface covered by solar panels is approx. 5.000 m<sup>2</sup> with a production of 500.000 kW per year
- » **2** \_ Rotational molding is the technology we use for the production of Twentyfirst pots. Our production plants are equipped with energy recovery systems that reduce energy consumption to the minimum while respecting the environmental ethics. Furthermore, production waste and scraps are reintegrated into the production cycle with a significant reduction of waste.
- » **3** \_ Our pots, at the end of their life cycle, are 100% recyclable through correct and responsible separate collection and transformed into new objects, creating a virtuous circle of sustainable consumption. Because together we can achieve a lot.

# 21ST

GARDENART

TWENTYFIRST IS A BRAND OF ELBI S.P.A.

---

*Thank you*

 Frank Rust

 +39 348 3548105

 [f.rust@elbi.it](mailto:f.rust@elbi.it)

